

Installer 2010

Wholesale Price List
1-800-662-5678

NEW FOR 2010

Full Selection of
Half Round Accessories in
Aluminum, Copper and
Galvanized Steel

Check out the back cover

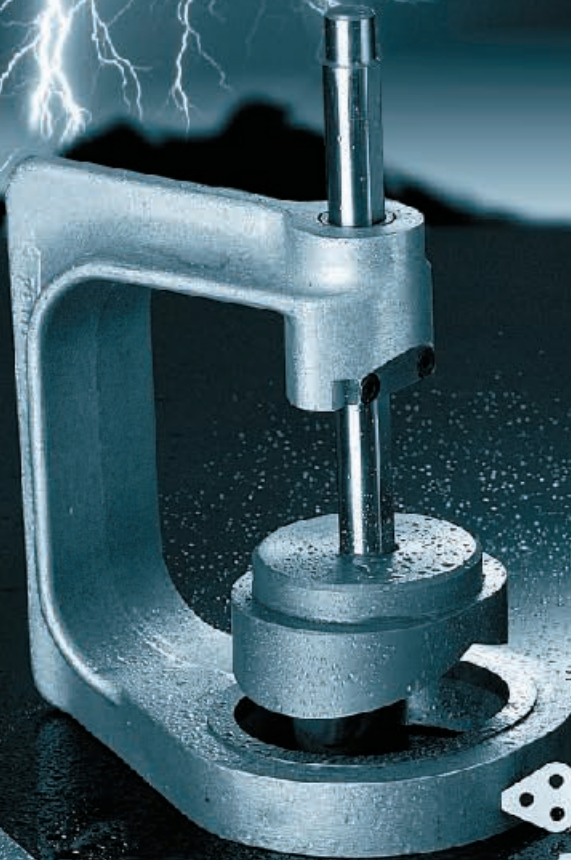

www.**Petit**
Tool.com

Quality, Price & Advice
Gutter Tools & Accessories for the Professional.

The Petit Outlet Punch

NEW

Available in:

**2 3/8" round • 2 3/4" round
3 3/8" round • 3" x 4" oval
3" and 4" for half round gutter**

Are you still using snips or a drill to cut holes for your drops?

That's slow and you're probably wasting a lot of time. The Petit Punch makes a perfect hole every time and it's fast and neat. The quality of the joint you wind up with is better than any other method.

The Petit Punch is a precision machined industrial grade tool. It's a major time and money saver. You can cut a proper hole in seconds and then tap in a perfectly fitting Popin Outlet. You save time and money with the less expensive round outlet while still maintaining the highest quality standards. The fit-up between the gutter and outlet is tight and all that's needed is a bead of sealer for a no-leak installation.

The 3" x 4" oval punch will fit most oval outlets with a lip for fastening with rivets or screws. The oval has the advantage that you can turn an elbow.

Our new 3 3/8" round punch is for 6" gutter, the outlet is too big to fit most 5" gutter. You will save time and money and pass more water with our 3 3/8" round Popin.

These punches are heavy duty and almost indestructible in proper use. You can have it sharpened at any tool shop or just send it back to us and we'll fix it up like new for a nominal charge. The smaller round punches fit 5" gutter, and the 3" x 4" oval punch can be used with 5" or 6" gutter. The 3 3/8" round fits 6" gutter and some 5" gutter. The 3" and 4" round punches fit 5" and 6" half round gutter—*call for details 1-800-662-5678.*

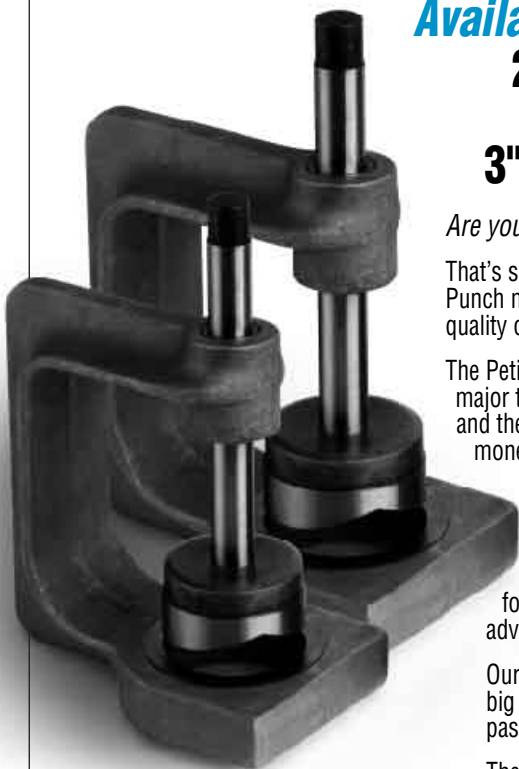

3" Round **\$159.00 ea.** **HRDP3**

4" Round **\$159.00 ea.** **HRDP4**



3" x 4" Oval **\$216.00 ea.** **OVP34**

2 3/4" Round **\$143.00 ea.** **RDP234**

2 3/8" Round **\$143.00 ea.** **RDP238**

3 3/8" Round **\$149.00 ea.** **RDP338**

3 lb. Zinc-Aluminum Hammer

Not too hard, not too soft,
just right for use with the Petit Punches.
Industrial quality—American made.
One or two hits and you have your hole—
safe, fast, easy. 4 lbs.

\$20.00 ea.

ZH3



Flat Screens

Fits 5"K style gutter. Mill finish.

30 PER BOX • 5 lbs.

\$25.20/box • .84 ea.

FS5

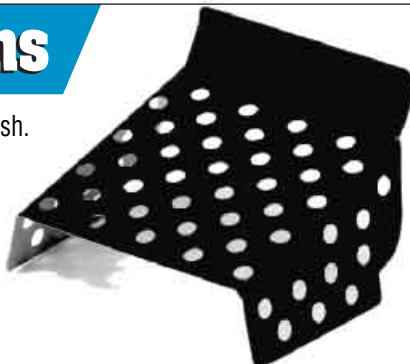

Round Wire Strainers

Made from galvanized steel.
Form to fit any shape outlet.

3" 36 PER BOX • 7 lbs. **\$63.00/box \$1.75 ea.** **WS3**

4" 36 PER BOX • 7 lbs. **\$75.60/box \$2.10 ea.** **WS4**

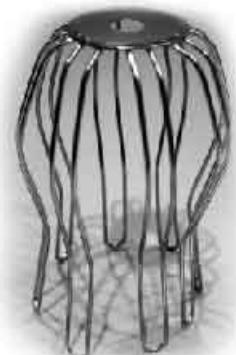

Round Popin Outlets

Now available 2 3/8", 2 3/4" and 3 3/8" for 6" gutter. Mill finish aluminum. The original precision Popin for use with the Petit Round Punch. Big, round outlets flow more, clog less and save bucks.



| | | | |
|--|---------------|--------------------------|----------------------------|
| 2 3/8" | RD0238 | 250 PER CARTON • 9 lbs. | |
| | | 1-39 boxes | \$87.50/box .35 ea. |
| 2 3/4" | RD0234 | 40-99 boxes | \$82.50/box .33 ea. |
| MINI PACK 50 per box \$23.00/box .46 ea. | | | |
| 3 3/8" | RD0338 | 100 PER CARTON • 10 lbs. | |
| | | for 6" gutter | \$71.00/box .71 ea. |
| MINI PACK 25 per box \$20.50/box .82 ea. | | | |

Rectangular Outlets

Mill finish aluminum.

| | | |
|----------------|-----------------------|------------|
| 2" x 3" | 30 PER BOX • 2 lbs. | R03 |
| | \$16.80/box | .56 ea. |
| 3" x 4" | 36 PER BOX • 4.5 lbs. | R04 |
| | \$40.68/box | \$1.13 ea. |



End Caps

The Petit End Cap—5". Deep and wide lip to accept the widest variety gutter contours. Easy to crimp or rivet. No creases. Standard colors available.



| | | |
|------------------------------------|--------------------|---------|
| HEAVY GAUGE (.024") | | |
| 100 PER CARTON • 7 lbs. | | |
| 1-24 boxes | \$36.00/box | .36 ea. |
| 25+ boxes | \$32.00/box | .32 ea. |
| EC5 | | |
| 6" END CAPS—50 PER CARTON • 3 lbs. | | |
| | \$35.00/box | .70 ea. |
| EC6 | | |

Oval Outlets

Mill finish aluminum. Use 3" x 4" with our oval punch.

| | | |
|----------------|-----------------------|------------|
| 2" x 3" | 30 PER BOX • 2 lbs. | 003 |
| | \$21.60/box | .72 ea. |
| 3" x 4" | 50 PER BOX • 4.5 lbs. | 004 |
| | \$41.50/box | .83 ea. |



DOWNSPOUTS & ELBOWS

2" x 3" Leader

White, brown and other standard colors. Special shipping required.

| | |
|--------------------------------|-----------|
| 100 FT. PER BOX • 25 lbs. | L3 |
| Call for current price. | |



3" x 4" Leader

| | |
|--------------------------------|-----------|
| 150 FT. PER BOX • 50 lbs. | L4 |
| Call for current price. | |

Elbows 2" x 3"

White, brown and other standard colors. .019" thick. Style A or B.

| | |
|----------------------|-----------|
| 36 PER BOX • 10 lbs. | EA |
| \$27.00/box | .75 ea. |

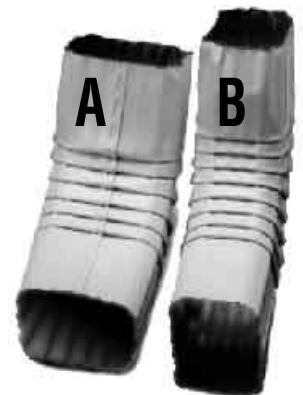

Elbows 3" x 4"

White, brown and other standard colors. .024" thick. Style A or B.

| | |
|----------------------|------------|
| 20 PER BOX • 10 lbs. | EB |
| \$24.80/box | \$1.24 ea. |

MITERS & DEFLECTORS

Strip Miters

90° for inside or outside 5" or 6". White, brown and other standard colors.

| | | | |
|--------------------------------|------|--------------------|------------|
| .032" • 20 PER CARTON • 3 lbs. | | | |
| 5" | 1-19 | \$30.40/box | \$1.52 ea. |
| | 20+ | \$28.40/box | \$1.42 ea. |
| SM5 | | | |
| .032" • 20 PER CARTON • 4 lbs. | | | |
| 6" | | \$86.00/box | \$4.30 ea. |
| SM6 | | | |



Bay Strip Miters

22 1/2" for 5" and 6" gutter. Available HG white, royal brown, and LG white for painting. Inside or outside.

| | | |
|------------|--------------------------------|------------|
| 5" | .032" • 20 PER CARTON • 3 lbs. | BA5 |
| | \$32.40/box | \$1.62 ea. |
| 6" | \$90.00/box | \$4.50 ea. |
| BA6 | | |



Deflectors

Precision cut valley splash deflectors. 4 3/4" high, 18" long. .032 aluminum in high gloss white or royal brown.

| | |
|--------------------------------|------------|
| .032" • 25 PER CARTON • 7 lbs. | DEF |
| \$24.50/box | .98 ea. |



Box Miters

Inside or outside 5" or 6". White, brown and other standard colors.

| | | |
|------------|-----------------------------|------------|
| 5" | 20 PIECES PER BOX • 10 lbs. | BM5 |
| | \$63.00/box | \$3.15 ea. |
| 6" | \$182.00/box | \$9.10 ea. |
| BM6 | | |



Hidden Hangers

5" Aluminum. Superior strength, both front and rear. C-channel cross bar. Punched to accept our optional roof strap. The strongest standard hidden hangers available.



5" Universal Hidden Hanger—
clips over back of gutter for easy installation.

5" No-Clip Universal Hidden Hanger—
no back clip, so fits flush to fascia board.

| | | | |
|------------|-----------------------------|----------------|--------------|
| | 250 PER BOX • 12 lbs. | | |
| 1-24 boxes | \$72.50/box | .29 ea. | UHH5 |
| 25+ boxes | \$67.50/box | .27 ea. | NIH5 |
| | 1000 PER BULK BOX • 50 lbs. | | UHH5B |
| Bulk Pack | \$200.00/box | .20 ea. | NIH5B |

Optional roof strap made for a tight twist fit in all our Hidden Hangers.

| | | |
|--|-----------------------|----------------------------|
| | 100 PER PACK • 4 lbs. | |
| | \$22.00/box | .22 ea. UHHS |

Screw Hangers - 5" + 6"

Aircraft grade aluminum makes them super strong. Special screws drive easier and hold better. Patented "drive thru screwing" for strength and economy. Punched to accept our optional roof strap. With or without clip for hem back.



| | | | |
|------------------|-----------------------|--------------------|--------------------|
| 5" | 500 PER BOX • 35 lbs. | | |
| | \$165.00/box | .33 ea. | PSH5 PSH5NC |
| MINI PACK | 100 PER BOX | \$37.00/box | .37 ea. |
| 6" | 300 PER BOX • 32 lbs. | | |
| | \$153.00/box | .51 ea. | PSH6 PSH6NC |
| MINI PACK | 50 PER BOX | \$28.00/box | .56 ea. |

Monster Hangers

5" Monster Hanger—

extra strong; deep drop in back for easy installation. Full 1 1/2" width!

| | | |
|-----------|-----------------------|----------------|
| | 150 PER BOX • 15 lbs. | |
| 1-9 boxes | \$67.50/box | .45 ea. |
| 10+ boxes | \$64.50/box | .43 ea. |

| | | |
|--|----------------------------|----------------|
| | 400 PER BULK BOX • 40 lbs. | |
| | \$156.00/box | .39 ea. |

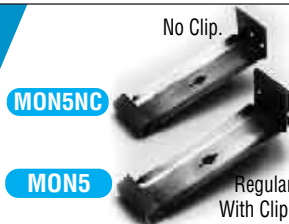

MON5NC No Clip.

MON5 Regular With Clip.

MON5B No Clip.

MON5NCB Regular With Clip.

6" Monster Hanger—

Super strong—full 2" width! Deep drop in back for easy installation.

| | | |
|-----------|-----------------------|----------------|
| | 100 PER BOX • 14 lbs. | |
| 1-9 boxes | \$64.00/box | .64 ea. |
| 10+ boxes | \$60.00/box | .60 ea. |

| | | |
|--|----------------------------|----------------|
| | 250 PER BULK BOX • 40 lbs. | |
| | \$145.00/box | .58 ea. |

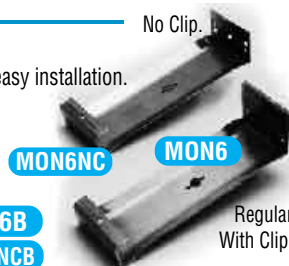

MON6NC No Clip.

MON6 Regular With Clip.

MON6B No Clip.

MON6NCB Regular With Clip.

6" Universal Hidden Hanger

WITH CLIP

Aluminum, another great Petit Tool value. Punched to accept our optional roof strap. Clips over the back of the gutter.

| | | |
|-----------|-----------------------|----------------|
| | 150 PER BOX • 12 lbs. | |
| 1-9 boxes | \$67.50/box | .45 ea. |
| 10+ boxes | \$64.50/box | .43 ea. |

UHH6



With Clip.

NO CLIP

Punched to accept our optional roof strap. No back clip, so it fits flush to the fascia board.

| | | |
|-----------|-----------------------|----------------|
| | 150 PER BOX • 12 lbs. | |
| 1-9 boxes | \$67.50/box | .45 ea. |
| 10+ boxes | \$64.50/box | .43 ea. |

UHH6NC

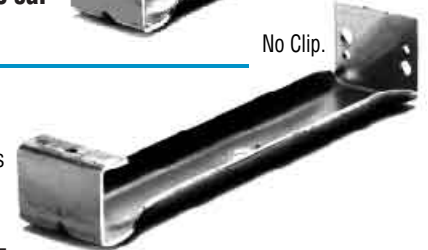

No Clip.

The Vampire™

With the vampire fangs—.063" Mill finish Aluminum, solid spun rivet.

Use the T-Bar Tool on page 7



| | | |
|-----------|-------------------------------------|----------------|
| | 100 PER BOX • 8 lbs. | |
| 5" | 1-35 cartons \$64.00/carton | .64 ea. |
| | 36-99 cartons \$62.00/carton | .62 ea. |
| | 100+ cartons \$60.00/carton | .60 ea. |

VAM5

| | | |
|-----------|------------------------------------|----------------|
| | 100 PER BOX • 10 lbs. | |
| 6" | 1-15 cartons \$90.00/carton | .90 ea. |
| | 16+ cartons \$86.00/carton | .86 ea. |

VAM6

Rod & Nut Vampire T-Bar

The rod & nut lets you set exact pitch while on the ground. Known as the Alcoa System. Rod & nut sold separately or with the Vampire T-Bar Hanger. 10", 5/16" dia. rod.

| | | |
|--|------------------------------------|----------------|
| | ROD & NUTS 100 PER CARTON • 9 lbs. | |
| | \$77.00/box | .77 ea. |

RN

HANGERS ONLY 100 PER CARTON • 9 lbs.

| | | | |
|-----------|--------------------|----------------|------------|
| 5" | \$21.00/box | .21 ea. | RH5 |
| 6" | \$30.00/box | .30 ea. | RH6 |

COMPLETE 100 PER CARTON • 9 lbs.

| | | | |
|-----------|--------------------|----------------|--------------|
| 5" | \$93.00/box | .93 ea. | RNWH5 |
| 6" | \$99.00/box | .99 ea. | RNWH6 |

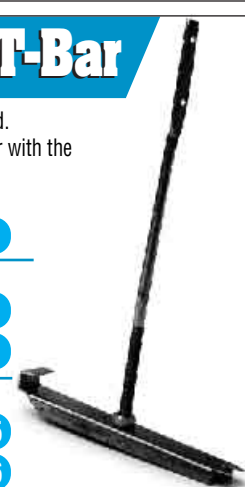

Toboggan Hanger

Canadian Bar Hanger supports the front lip of gutter. Good for problem installations. Helps deflect snow and ice over gutter. Heavy mill finish aluminum.

| | | |
|--|-----------------------|----------------|
| | 100 PER BOX • 10 lbs. | |
| | \$50.00/box | .50 ea. |

TOB5



PIPE & GUTTER ACCESSORIES

Pipe Bands

.032" or .027" thick, assorted colors. The strongest, best looking—not gaudy.

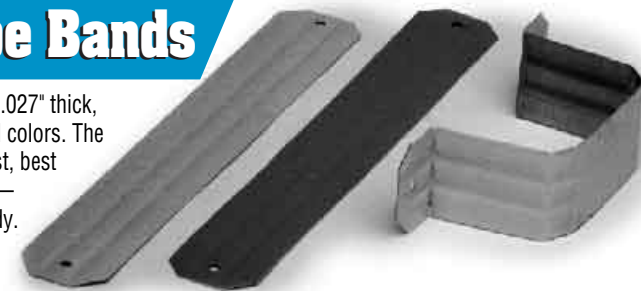

| | | |
|--------------------------------|--------------------|----------------|
| 2" x 3" • 100 PER BOX • 4 lbs. | | |
| 1-49 boxes | \$20.00/box | .20 ea. |
| 50+ boxes | \$18.00/box | .18 ea. |
| PB3 | | |
| 3" x 4" • 100 PER BOX • 5 lbs. | | |
| 1-19 boxes | \$28.00/box | .28 ea. |
| 20+ boxes | \$25.00/box | .25 ea. |
| PB4 | | |

Wraparound Pipe Bands

.027" thick, assorted colors. Same appearance as our standard pipe band but attachments to building are behind the pipe and the band is wrapped all the way around, overlapped, and fastened on the side. Neat!

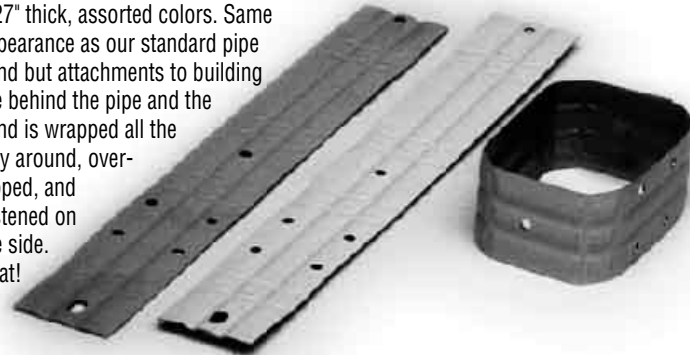

| | | |
|--------------------------------|--------------------|----------------|
| 2" x 3" • 100 PER BOX • 5 lbs. | | |
| 1-49 boxes | \$20.00/box | .20 ea. |
| 50+ boxes | \$18.00/box | .18 ea. |
| WPB3 | | |

Pipe Cleats

Good on masonry and clapboard. White and brown.



| | | |
|---------------------------|--------------------|----------------|
| 100 PER BOX • 2 lbs. | | |
| For 2" x 3" | \$20.00/box | .20 ea. |
| For 3" x 4" | \$22.00/box | .22 ea. |
| PC3 4 1/2" wide | | |
| PC4 5 3/4" wide | | |

Pipe Clips

.032 Aluminum, all standard colors, won't show from the front.



| | | |
|--------------------------|----------------|--------------|
| 3" • 50 PER BOX • 3 lbs. | | |
| \$11.50/box | .23 ea. | CLIP3 |
| 4" • 50 PER BOX • 6 lbs. | | |
| \$14.50/box | .29 ea. | CLIP4 |

Gutter Guard

NEW COLORS!

4' Lengths. Mill finish aluminum or most standard gutter colors—sheds leaves and pine needles, heavy gauge, simple to install. 5" Gutter Guard for most installations.

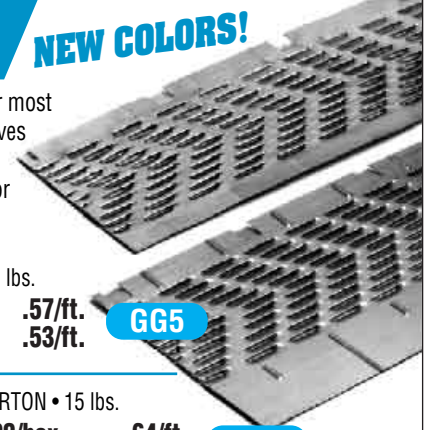

| | | |
|------------------------------|--------------------|----------------|
| 100 FT. PER CARTON • 12 lbs. | | |
| 1-19 boxes | \$57.00/box | .57/ft. |
| 20+ boxes | \$53.00/box | .53/ft. |
| GG5 | | |
| 100 FT. PER CARTON • 15 lbs. | | |
| 1-19 boxes | \$64.00/box | .64/ft. |
| 20+ boxes | \$60.00/box | .60/ft. |
| GG6 | | |

7 1/4" Gutter Guard when you need extra, extra width.

| | | |
|------------------------------|--------------------|----------------|
| 100 FT. PER CARTON • 15 lbs. | | |
| 1-19 boxes | \$71.00/box | .71/ft. |
| 20+ boxes | \$68.00/box | .68/ft. |
| GG7 | | |

Gutter Screen



4' lengths. Expanded mill finish aluminum. 5" or 6" wide.

| | | |
|------------------------------|---------------------|----------------|
| 200/FT. PER CARTON • 18 lbs. | | |
| \$92.00/box | .46/ft. | SCRN5 |
| 160/FT. | \$110.40/box | .69/ft. |
| SCRN6 | | |

Gutter Sealer



OSI brand S.B.R. gutter and seam sealant. White or Aluminum. Reliable and economical.

| | | |
|-----------------------|-------------------|------------|
| 24 PER CASE • 14 lbs. | | |
| \$59.52/box | \$2.48 ea. | OSI |

Geocel brand sealant. White, aluminum or clear. Doesn't puddle. Great adhesion, will work on wet metal.



| | | |
|----------------------|-------------------|------------|
| 24 PER CASE • 8 lbs. | | |
| \$70.80/box | \$2.95 ea. | GEO |

24 PER CASE • 20 lbs.

| | | |
|--------------------|-------------------|-------------|
| \$87.60/box | \$3.65 ea. | GEOC |
|--------------------|-------------------|-------------|



Clear or white silicone sealant. Superior adhesion, 25-year life.



| | | |
|-----------------------|-------------------|-------------|
| 12 PER CASE • 11 lbs. | | |
| \$47.40/box | \$3.95 ea. | SILC |

Caulking Gun

Has all of the features: Seal puncture tool, Spout cutter, Ladder hook, Instant flow stop thumb release.



And...3 times the squeeze by design.

| | | |
|-------------------|-------|-------------|
| \$4.95 ea. | 2 lb. | CGUN |
|-------------------|-------|-------------|

WEDGES, SPACERS & SPLASH BLOCKS

Gutter Wedges

STANDARD

Our own invention! Used to plumb a slanted fascia, will handle approximately 5/12 pitch or 28°. On our shelf in white and brown for 5" and 6" gutter.

.032" • 100 PER BOX • 4 lbs.

5" 1-24 boxes **\$33.00/box** .33 ea.
25-99 boxes **\$30.00/box** .30 ea.

GW5

6" .032" • 50 PER BOX • 4 lbs.
\$36.00/box .72 ea.

GW6

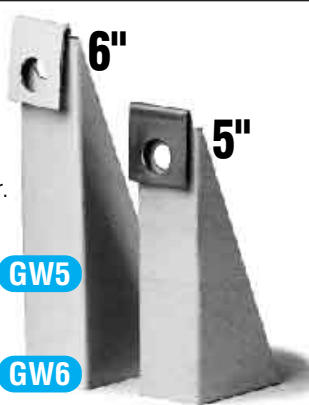

Steep Gutter Wedges

These new wedges will plumb gutter up to a 12 / 12 roof.

Trim back for less steep pitches.

5" in white or brown.

.032" • 50 PER BOX • 4 lbs.

\$28.00/box .56 ea. **SGW5**



2 x 3 Spacers

Use these spacers in various ways to position the gutter under a projecting roof. White or brown.

NEW

.032" • 50 PER BOX • 5 lbs.

\$36.50/box .72 ea. **SPAC3**



Splash Blocks

Designed to keep water away from foundation.

24" long, sloped for positive run-off.

Reinforced plastic. Green, slate or sandstone. 3 lbs.

1-9 **\$5.40 ea.**

10+ **\$4.95 ea.**

SB



WEIRD STUFF HALF ROUND, COPPER, GALVANIZED, ALUMINUM, LEAD COATED

If you've got a wild & crazy job, we've got all this stuff.



From supreme quality European copper, to old farm half round galvanized, we sell it all.

So...if you do this kind of work, you should call Petit for a quote.

Down Spout Adapters

Connect Downspouts to 4" plastic soil pipe.

Choose centered or offset.

White PVC.

NEW

2" x 3" **\$2.75 ea.**

3" x 4" **\$4.30 ea.**

DSA



COLORED & COPPER MINI COILS

Painted Aluminum Gutter Coil from Hastings

11 3/4" & 15"



Rerolled and boxed in approximately 65#/170' coils. Ready to ship UPS. Enough to do most jobs. Available in all of our standard colors.

CALL FOR PRICE **COIL S**

Copper mini coils. 16 oz. in 11 3/4" & 15". Custom rolled and boxed. CALL FOR PRICE.

Spikes

Aluminum Gutter Spike. Brown or White painted head. Other colors available.



7" 500 PER CARTON • 15 lbs.
\$85.00/box .17 ea. **GS7**

8" 500 PER CARTON • 17 lbs.
\$95.00/box .19 ea. **GS8**

Ferrules

The Petit Ferrule. Heavy aluminum, round, strong, and tight. No internal fin.

5" Ferrule-MINI BOX (500 COUNT • 7 lbs./box)

1-49 boxes **\$24.50/box** .06 ea. **FMIN5**
50+ boxes **\$22.00/box** .05 ea.

MASTER BOX (2500 COUNT • 34 lbs./box)

1-19 boxes **\$81.00/box** .035 ea. **FMAS5**
20+ boxes **\$74.00/box** .030 ea.

6" Ferrule-MINI BOX (500 COUNT • 9 lbs./box)

1-24 boxes **\$32.00/box** .06 ea. **FMIN6**
25+ boxes **\$27.00/box** .05 ea.

MASTER BOX (2000 COUNT • 35 lbs./box)

\$84.00/box .042 ea. **FMAS6**



Pop Rivet Tool

Malco Riveter • 2 lbs.
\$19.50 ea. **CR18**

Marsan Riveter • 2 lbs.
\$26.50 ea. **HP-2**



Pop Rivets

Standard Colors. 1/8" dia. Aluminum. 500 pack weighs 12 oz. per pack 10,000 box weighs 12 lbs.

#42 GRIP RANGE 1/16" to 1/8"

500 per pack **\$7.20/pack** .0138 ea. **PR42**
10,000 per box **\$135.00/box** .0135 ea.

#43 GRIP RANGE 1/8" to 3/16"

500 per pack **\$8.90/pack** .0170 ea. **PR43**
10,000 per box **\$145.00/box** .0140 ea.

Drill Bits

Double ended, high speed, 2" long. .1285 split point. Malco product. Makes oversize hole for 1/8" pop rivet.

PACKAGE OF 12
\$17.00/pack
\$1.50 ea. **DE**



Nail Shooter Kerbonger

Makes it easy to drive your hanger nails. 7" reach.

1-9 **\$8.00**
10+ **\$7.00** 1 lb. **NS**



UHH—Maze Nails

2" screw shank with 9/32" head. Fits nail shooter. Use with hidden hanger. Double dip galvanized. Lifetime warranty against red rust.

\$9.50 / 5 lbs.
\$90.00 / 50 lbs. **UHHN**



Hammer Drive

Fits 3/4" to 3" Drive Nails. Save your hands. 2 lbs.

\$18.75 ea. **HDT**



Drive Nails

100 per box. Price per hundred. Use in masonry or concrete.

3/4" **\$10.00**
1" **\$10.80**
1 1/4" **\$11.30**
1 1/2" **\$11.90**
2" **\$13.75** **DN**

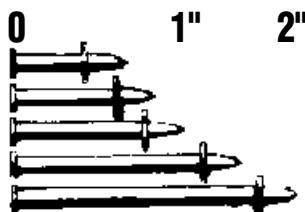

Zip Screws

Sharp point, 1/4" hex head.

1/2" Zinc plated steel, painted in standard colors.
#7 { 1,000 per pack **\$14.00/pack** .014 ea. **ZS7**
10,000 per box **\$126.00/box** .013 ea.

1 1/2" Zinc plated steel, for hidden hangers.
#10 { 1,000 per pack **\$28.50/pack** .029 ea. **ZS10**
5,000 per box **\$126.00/box** .026 ea.

1 1/2" Zinc plated steel, Petit Custom Hanger Screw in the "Pouch Pack"
#11 { 1,000 per pack **\$27.00/pack** .027 ea. **ZS11**
3,000 per box **\$72.00/box** .024 ea.

3/8" Stainless Steel, painted in standard colors. Good for service in salt air regions.
#6 { 1,000 per pack **\$26.00/pack** .026 ea. **ZS6**
10,000 per box **\$250.00/box** .025 ea.



Zip Screw Driver

4" or 6" long, 1/4" hex magnetic chuck driver. Good for driving all of our zip screws, or the Petit Screw Hangers.

1-9 **\$8.00** **ZSD6**
10+ **\$7.00**

1-9 **\$7.00** **ZSD4**
10+ **\$6.00**



Zip Screw Shooter with 1/4" chuck

Perfect tool to help line up hanger screws, has a super strong magnet and 6" reach. The oversized barrel will take any gutter screw.

\$9.00 ea. **ZSS** Replacement Chucks **\$2.00 ea.** **ZSC**





Snap Lock Punches

Used for crimping on end caps.

Punch impression 3/8" from edge of metal.
Heavy forged cutting jaw. 21/2 lbs.

\$34.00 ea. SL1

Slide adjustment for throat depth allows settings from 1/4" to 5/8". Formed metal cutting jaws. 2 lbs.

\$27.00 ea. SL2

C4 (5) Blade Hand Crimper

For joining identical size pipe—round, square or corrugated. Double crimp. 1 1/4" throat depth. 9" long, 2 lbs.

\$20.00 ea. C4

SCI Hand Crimper

Fast, easy to use and light weight. Perfect for downspout corners—round, square and corrugated pipe. 2 lbs.

\$16.00 ea. SC1

The Vampire™ T-Bar Tool

For installing the Vampire Hanger. 2 lbs.

\$16.00 ea.

TBT



Heavy Duty 12" Hack Saw

Malco HS90

Extra deep. 4 3/4" throat so it's perfect for gutter work.

4 3/4" Throat

\$25.00 ea. 2 lbs.

HS90

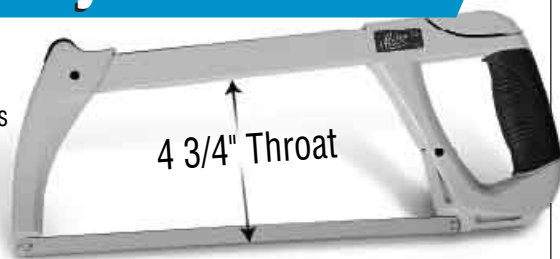

Sheet Metal Snips

Powerful, compound leverage. Industrial quality. Made in the U.S.A.

1R Red • Snips cut left **1R**

2R Green • Snips cut right **2R**

3R Yellow • Combo & straight cuts **3R**

1 lb.
\$13.00 ea.



Stab-In Snips

Stab your leader with the sharp lower blade and complete the cut without distortion.

These work great!

\$24.00 ea.

4R



Andy Snips 12"

Heavy duty but light weight.

\$23.00 ea. 1 lb. M12

Replacement blades with rivets.

\$12.00/set M12RB



Scratch Awls

Extruded tenite handle, Orange anti-roll. Heat treated and tempered for resharping.



A-00 pkg. of 12 (1 lb.) **\$27.60/pack** **\$2.30 ea.**

1/8" dia. has 3" blade (\$2.50 ea. separately)

A-00

A-20 pkg. of 6 (2 lbs.) **\$25.80/pack** **\$4.30 ea.**

1/4" dia. has 4" blade (\$4.50 ea. separately)

A-20

Heavy Duty 12" Hack Saw

Malco HS90

Extra deep. 4 3/4" throat so it's perfect for gutter work.

4 3/4" Throat

\$25.00 ea. 2 lbs.

HS90

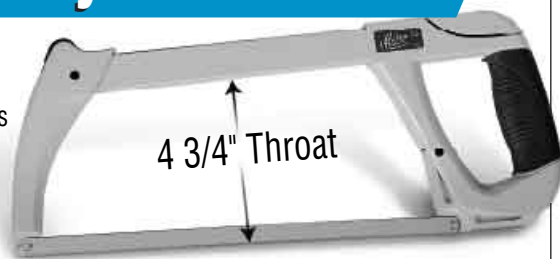

Half Round Gutter Clamp

Custom crafted by Petit

This tool makes perfect joints child's play—tight and right whether you solder, screw or rivet.

5" **\$149.00 ea.** HRGC5

6" **\$159.00 ea.** HRGC6



NEW

Tape Measures



American made by Starrett.
True-professional quality—bright yellow case.

30 feet long—
Full 1" wide TRU-LOK with the TOUGH-TIP

\$10.75 ea. • 1 lb.

TM30

100 foot rollup with
tipkeeper molded into the case.
Easy fit in your nail pouch.

\$14.50 ea. • 1 lb.

TM100



Wasp Spray

Wasp and hornet spray—Shoots 20 feet and
knocks 'em dead. Big 18 oz spray can.

12 per case • 15 lbs.

Full Case \$47.88 \$3.99 ea.
(\$3.99 ea. separately)

WASP



Touch-up Paints

White, brown and other standard colors.
Our private label. A perfect match.
Convenient for installers.

9 Ounces.
\$6.35 ea.

TUP



No Drip Strip

The simple problem solver.
Pull as much as you need out
of the coil box, snip it off, push it under
the drip edge so it hangs over the
back of the gutter, and back fasten it
if needed. No more dripping between
the fascia and gutter. Problem solved!
White, Mill Finish or Brown.

2" wide trim coil • .016-.20 gauge
325-400 feet per box

\$42.00/box • 17 lbs.

NDS



NEW

Runout Stands

Heavy Duty tri-pod
runout stands.

Replaceable
Non-Scratch
Velcro

\$89.00 ea. • 14 lbs.

STAND

27" - 45"
Height
Range

Instant
Self-Locking
Height
Adjustment

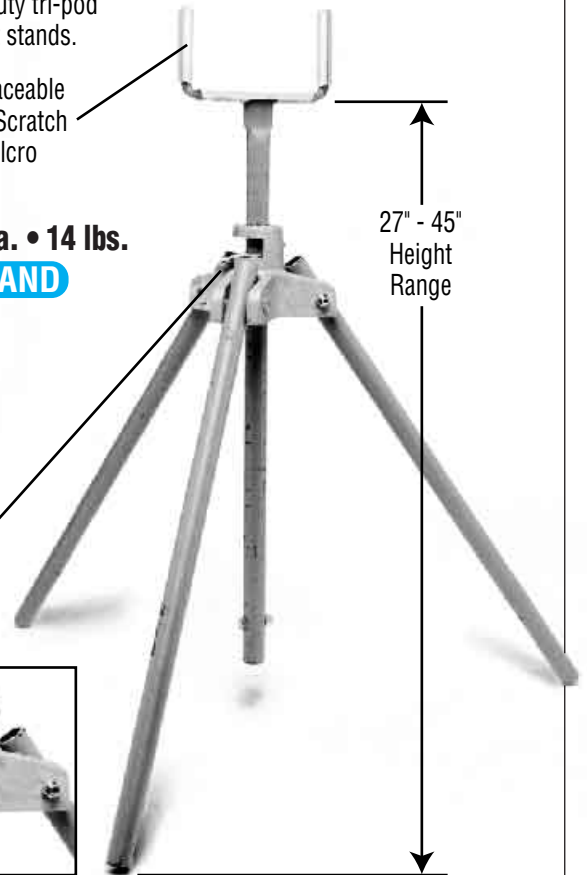

Zig Zag Elbows

NEW

The professional way to neatly jog a downspout.
They come in high white, low white, and royal brown.
For 2x3 or 3x4 leader. A or B style.

A

B

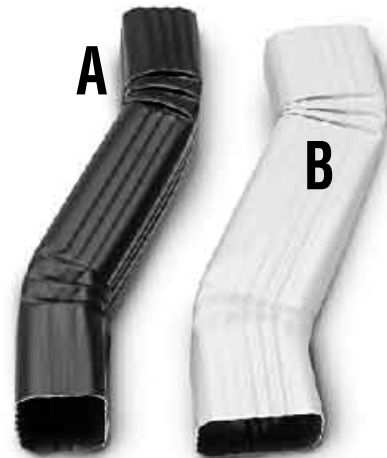

2x3 • Pick 2" or 3" offset
24 per box • 8 lbs.
\$39.60/box • \$1.65 ea.

ZZ3

3x4 • 3" offset
10 per box • 11 lbs.
\$50.00/box • \$5.00 ea.

ZZ4

SPRING SPECIALS

for the Gutter Industry

2010

Round Popin Outlets



Now available 2 3/8", 2 3/4" and 3 3/8" for 6" gutter. Mill finish aluminum. The original precision Popin for use with the Petit Round Punch. Big, round outlets flow more, clog less and save bucks.

2 3/8" RD0238 250 PER CARTON • 9 lbs. \$75.00/box .30 ea.

2 3/4" RD0234 250 PER CARTON • 9 lbs. \$75.00/box .30 ea.

MINI PACK 50 per box \$17.50/box .35 ea.

for 6" gutter
3 3/8" RD0338 100 PER CARTON • 10 lbs. \$60.00/box .60 ea.

MINI PACK 25 per box \$18.75/box .75 ea.

No Drip Strip



The simple problem solver.
Pull as much as you need out of the coil box, snip it off, push it under the drip edge so it hangs over the back of the gutter, and back fasten it if needed. No more dripping between the fascia and gutter. **Problem solved!**
White, Brown, Black or Mill Finish.

2" wide trim coil • .016-.20 gauge
325-400 feet per box

\$30.00/box • 17 lbs. **NDS**

Valley Splash Deflectors



At this price why cut your own?

Precision cut splash deflectors.
4 3/4" high x 18" wide • .032 aluminum
in high gloss white or royal brown.

\$20.00 per box of 25 • .80 each **DEF**

Half Round Gutter Accessories

Aluminum, Copper, Galvanized Steel



Outlets, end caps, hangers, offsets, we've got it all! If you can describe it, we probably sell it. So ... do your take off and call Petit for a price. No running around, UPS will bring it to your door.

www.PetitTool.com

P.O. Box 206 • 1387 WATERBURY ROAD
THOMASTON, CT 06787

TOLL FREE 1-800-662-5678

(860) 283-9626 • FAX (860) 283-6860 • www.petittool.com

Spring Specials Good Until 6/26/10 • All Prices F.O.B. Thomaston, CT